

STRATFORD 56" SOCCER TABLE - NG1034FB

Spec Sheet

Player Positions

(measurements from center of player and ends of rods, NOT including handles or end caps)

3 Player Rods (A, C, F & H, incl. stops): Starting from handle end of rod, 17", 7.25", 7.25", 13" = 44.5"*

2 Player Rods (B & G): Starting from handle end of rod, 21.75", 9.75", 17.75" = 49.25"*

5 Player Rods (D & E): Starting from handle end of rod, 12.5", 4.75", 4.75", 4.75", 4.75", 8.75" = 40.25"*

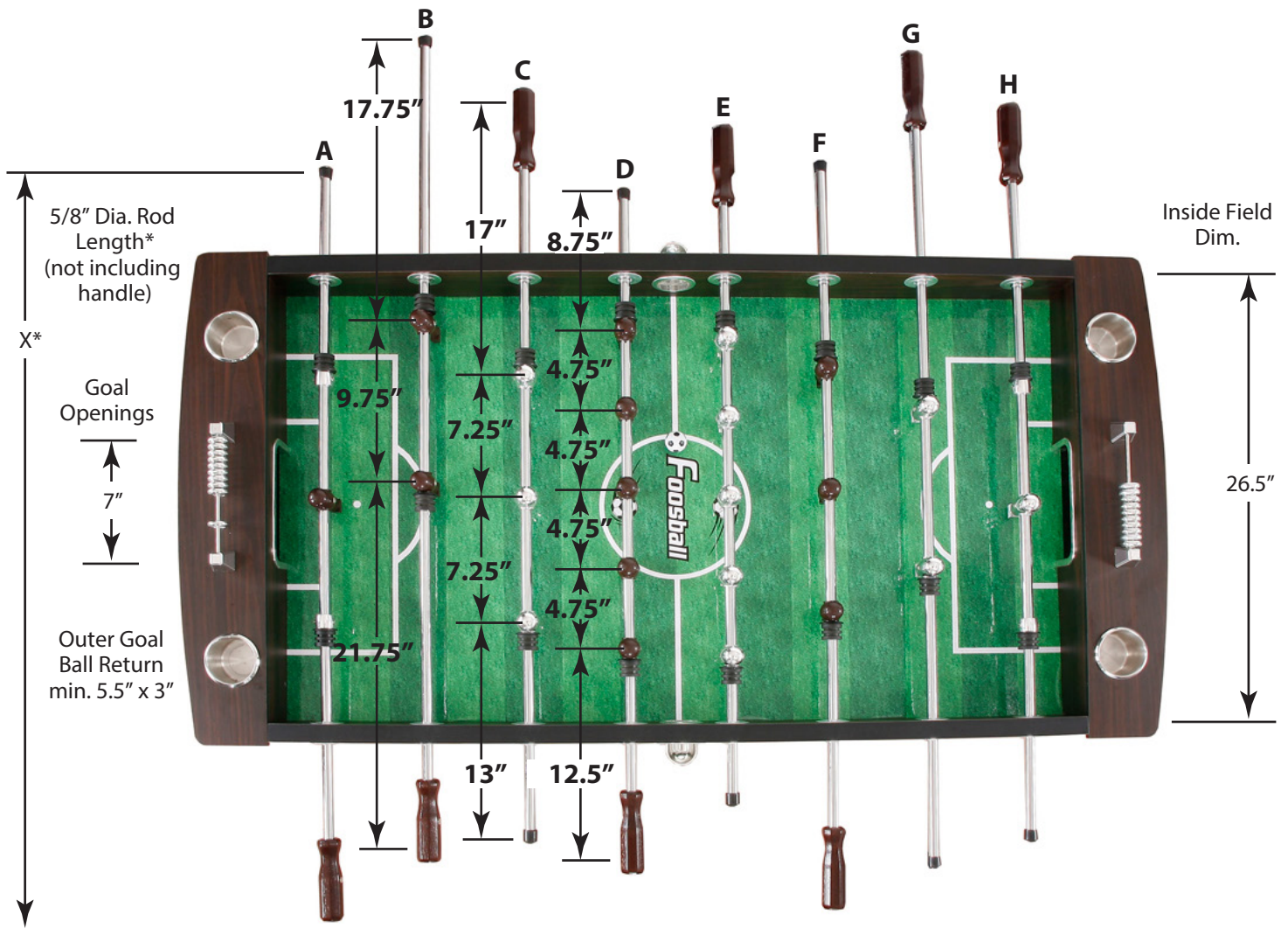







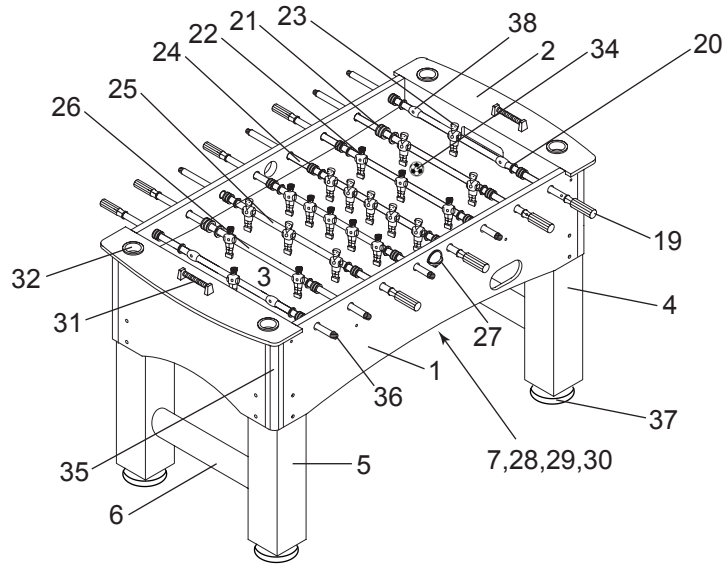





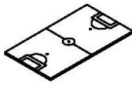













* Rod length varies depending on player count, **X = 3-Player Rod: 44.5"; 2-Player Rod: 49.25"; 5-Player Rod: 40.25"**
 Also, VERY IMPORTANT, rod ends, without handles or end caps, should NOT have sharp edges.

STRATFORD 56" FOOSBALL TABLE - NG1034FB

Spec Sheet

















PARTS

#1 NGP5966  SIDE PANEL	#2 NGP5967  END PANEL	#3 NGP5768  PLAYFIELD	#4 NGP5969  LEG - LEFT	#5 NGP5970  LEG - RIGHT	#6 NGP5971  LEG SUPPORT	#7 NGP5792  PLAYFIELD SUPPORT BRACE
#19 NGP5972  HAND GRIP	#20 NGP5794  PLASTIC ROD WASHER	#21 NGP5795  RUBBER BUMPER	#22 NGP5973  AWAY PLAYER	#23 NGP5974  HOME PLAYER	#24 NGP5798  5 PLAYER ROD	#25 NGP5799  3 PLAYER ROD
#26 NGP5800  2 PLAYER ROD	#27 NGP5801  2 PIECE BALL LAUNCHER	#28 NGP5802  BALL RUNNER	#29 NG5803  SIDE BALL CATCHER	#30 NG5804  BALL CATCHER	#31 NG5975  MANUAL SCORER	#32 NG58061  SILVER METAL CUP
#34 NGP5807  SOCCER BALL	#35 NGP5808  APRON CORNER	#36 NGP5809  ROD END CAP	#37 NG5810  LEG LEVELER	#38 NG5976  STOP RING		

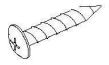
6/14

HARDWARE PACK - NGP5812

#8  5/16" FLAT WASHER	#9  5/16" BOLT	#10  1/4" BOLT	#11  1/4" FLAT WASHER	#12  1/2" SCREW	#13  1" FLAT SCREW	#14  1-1/8" BOLT
#15  LOCKNUT	#16  1/2" FLAT SCREW	#17  3/4" SCREW	#18  1-3/4" SCREW	#33  HEX WRENCH	#39  5/8" BOLT	ADDITIONAL EQUIPMENT REQUIRED:  PHILLIPS HEAD SCREWDRIVER